

User manual

DESIGN & TECHNICAL INFORMATION

OPERATION & CONTROL

MAINTENANCE & SERVICE

Exhaust air filter, article No: Q120101
Supply air filter, article No: Q120100

*Easy to
maintain*

*Efficient
heat recovery*

*Low noise
level*

*Low energy
consumption*



	Sid		
Design & technical information		Digital outputs	
Product description	3	Filter timer	
Casing	3	6. Alarm	14
Filter, exhaust air	3	Current alarm	
By-pass damper	3	Alarm history	
Fan, exhaust air	3	7. Load settings	14
Fan, supply air	3	8. Unlock functions	15
Heat exchanger	3	9. Authorization	15
Filter, supply air	3	Default user parameter setting	15
Inspection door	3	Options	
Adjustable feet	3	Remote panel – Simple	16
Condensate drain	3	Remote panel – 3-way	16
Control panel	3	Remote panel – with display	16
Reheater	3	Stove mode	18
Functional diagram - supply air control	4	Maintenance & service	
Chiller / Cooling coil (optional)	4	Cleaning	19
Technical specification	5	Changing filter	19
Dimensions	5	Cleaning the fans	19
		Cleaning the heat exchanger	19
Operation & control unit		Checking the condensate drain	19
Overview		Cleaning, air diffusers	20
Fel! Bokmärket är inte definierat.		Cleaning the duct system	20
Control unit main screen		Checking the outdoor air intake	20
The menu system		Service	20
How to change values and settings		Disposal	20
Menu screens, structure and contents			
Fel! Bokmärket är inte definierat.			
Main menu			
Version			
Language			
Address			
1. Temperature			
Fel! Bokmärket är inte definierat.			
Temperatures			
ECO-adjusts			
Control mode			
Limit for cooling			
2. Fan control	10		
Fan control			
3. Timer	11		
Time and summer / wintertime			
Activate timer			
Time schedule			
Weekend schedule			
4. Inputs / Outputs	12		
Status analog inputs			
Universal analog inputs			
Status digital inputs			
Status analog outputs			
Status digital outputs			
Calibration of temperature sensors			
5. Manual/Auto	13		
Supply air regulator			
Fans, bypass, heating and cooling			



General description

RT 250/400S-EC-RS is an air handling unit (compact cabinet) designed for ventilation of homes, offices, nurseries or other smaller premises. The Temovex unit is intended to be placed in heated spaces such as laundry room, boiler room, corridor or similar. The system consists in it's standard version of a counterflow heat exchanger, two fans, two filters, reheater, bypass damper and a control system.

Placement guide



1. Casing

The casing is made of hot galvanised sheet metal with 30 mm insulation between the sheets. As a standard, the side panels and the front are powder coated in white. The front door has a magnetic strip which keeps the door closed. The unit top has sleeve connections where all ducts are connected.

2. Exhaust air filter

Coarse 60%, bag (art. No. Q120101)

3. Bypass damper

The Temovex AHU has an automatic bypass damper which makes the air bypass the heat exchanger whenever heat recovery is not necessary. The bypass setting is adjusted on the control panel.

4. Exhaust air fan

The unit has low-energy fan of EC type with integrated overheating.

5. Supply air fan

The same type as exhaust air fan (see point 4)

6. Heat exchanger

Temovex counterflow heat exchanger is designed by our own staff and is the result of 30 years experience of high efficient counterflow heat exchangers.

The heat exchanger is made of thin aluminium sheets, and is completely sealed between the supply air and exhaust air. This is important in order to avoid odours and other contaminants to seeping through to the fresh air side. The heat exchanger has no moving parts, which eliminates wear.

7. Supply air filter

ePM1-50%, bag (art. No. Q120100).

8. Inspection door

When cleaning the heat exchanger or controlling the condensate drain, the Inspection door is opened. (See chapter "Maintenance & service").

9. Adjustable feet

The cabinet has adjustable rubber feet.

10. Condensate drain

The Temovex unit is fitted with a condensate drain at the bottom of the unit. This should be connected to a drain or fed to a floor drain.

11. Control panel

All settings for fan speed, reheating, bypass etc. are made via the control panel and the AHU's integrated control system.

If you have added optional parts to your Temovex AHU, these functions, too, are set via the control panel.

12. Reheater

RT 250/400S-EC-RS is fitted with an electric reheater, 0.9 kW.

As an optional extra, a reinforced electric reheater, 1,8 kW, or a water coil (two different sizes) for waterborne heating is offered. The heater is integrated in the unit and settings are made via the control panel.

In the case of a water coil, the water connections are at the top of the unit, dimension DN12.

RT 250/400S-EC-RS with water coil includes a two-way valve and valve motor in the delivery from REC.

Functional diagram

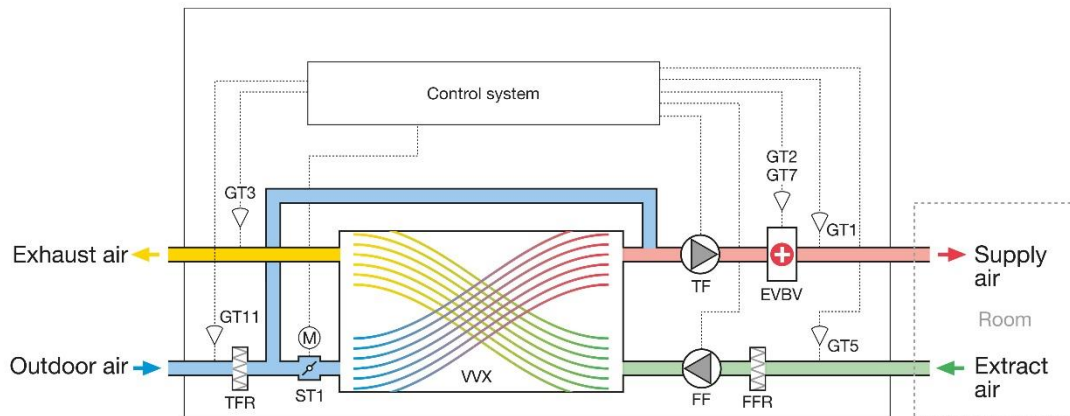

- | | | | |
|------|---|-----|---|
| V VX | Counterflow heat exchanger | TF | Fan, Supply air |
| ST1 | Bypass damper | FF | Fan, Exhaust air |
| EVB | Reheater, electricity/water | GT2 | Over heat protection (with electric heater) |
| GT1 | Temperature sensor, Supply air (red sensor) | GT3 | Temperature sensor, Exhaust air (yellow sensor) |
| GT11 | Temperature sensor, outdoor air (blue sensor) | GT7 | Freeze protection (when water coil) |
| TFR | Filter, Supply air (Outdoor air) | GT5 | Temperature sensor, Extract air (green sensor) |
| FFR | Filter, Exhaust air | | |

Chiller (cooling coil) EKB (optional)

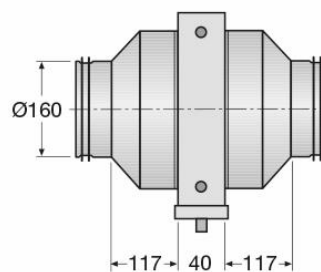
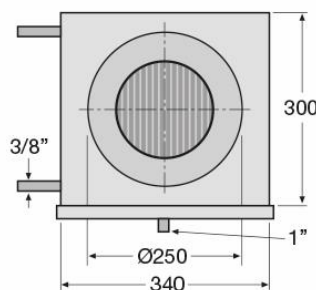

Tecnical specification

	Electric heater		Water heater	
	RT250	RT400	RT250	RT400
Rated electric power (total)	1041 W	1145 W	141 W	245 W
fans	134 W	238 W	134 W	238 W
heater	900W		-	-
Extended heater (option)	900W		-	-
Power, water coil small	-	-	1150 W ¹	1500 W ¹
Power, water coil big (option)	-	-	2000 W ¹	2800 W ¹
Water connection	-	-	DN12	
Voltage/Frequency	230 V, 50 Hz			
Fuse	10 A			
Filter, supply air / exhaust air	Bag: art nr. Q120100 / Bag: art nr. Q120101			
Weight	100 kg			
Brandklass	A15			
Dimensions (WxDxH)	430x620x1900 mm			
Duct connections	4 x Ø160 mm			
Condensate drain	¾+			
Storage Temperature Range	-20 ÷ . +50°C			
Operating Temperature	0 ÷ . +50°C			

¹At water temp. 55/45 °C and 70% of maximum flow.

Dimensions

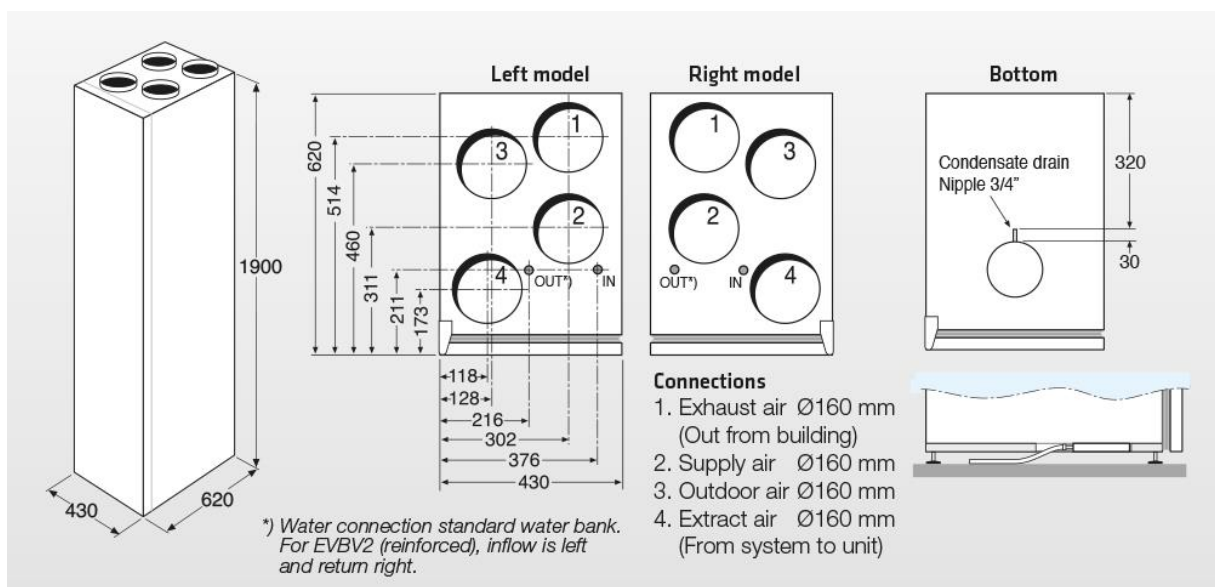







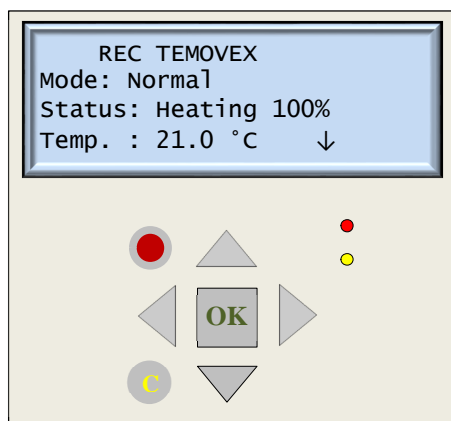

General

This is a description of the basic functions that you can modify to suit your own preferences and circumstances. The unit's control system optimizes the function according to the settings you make. As a user of the air handling unit it is good to know the following:

In the menus for heating and cooling, where you as a user have the possibility to make changes, the %auto mode+ is the most optimized function. Should you choose a manual setting, On or Off, the manual settings take precedence.

Control unit



-  Up
-  Down
-  Right
-  Left
-  Confirm
-  Show alarm
-  Delete

● Alarm	Flashing	There are one or more alarms that have not been acknowledged.
	Steady	There are one or more acknowledged alarms left.
● Setting	Flashing	You are in a menu where it is possible to change some parameters.
	Steady	You are now in change position.

Menu system.

The unit's various settings and the status of different values such as temperature etc. Can be viewed by scrolling around in the menu system. Certain parameters and operational settings can also be changed. No basic system configurations can be changed without authorization code (technician level).

There is a main menu that the system automatically reverts to approx. 25 minutes after the keys have been last touched. The system also automatically logs you out after this time if you have logged in with a code.

How to change values and settings

Scroll to the desired menu using the arrow keys. Press %OK+, and the adjustable variable will start blinking. Change with the up or down arrow keys. Moving between lateral positions is done with the right or left arrow key. When the correct value is set, confirm with %OK+. The cursor then moves to the other alterable variable in the same menu.

Menus and their structure

In the manual the various menus are shown looking as closely as possible as they appear on the hand terminal. The possible jumps between the menus are also shown in the manual. More detailed information for certain menus will, where relevant, be shown after the respective section. Begin the trek through the menus here at the main menu.

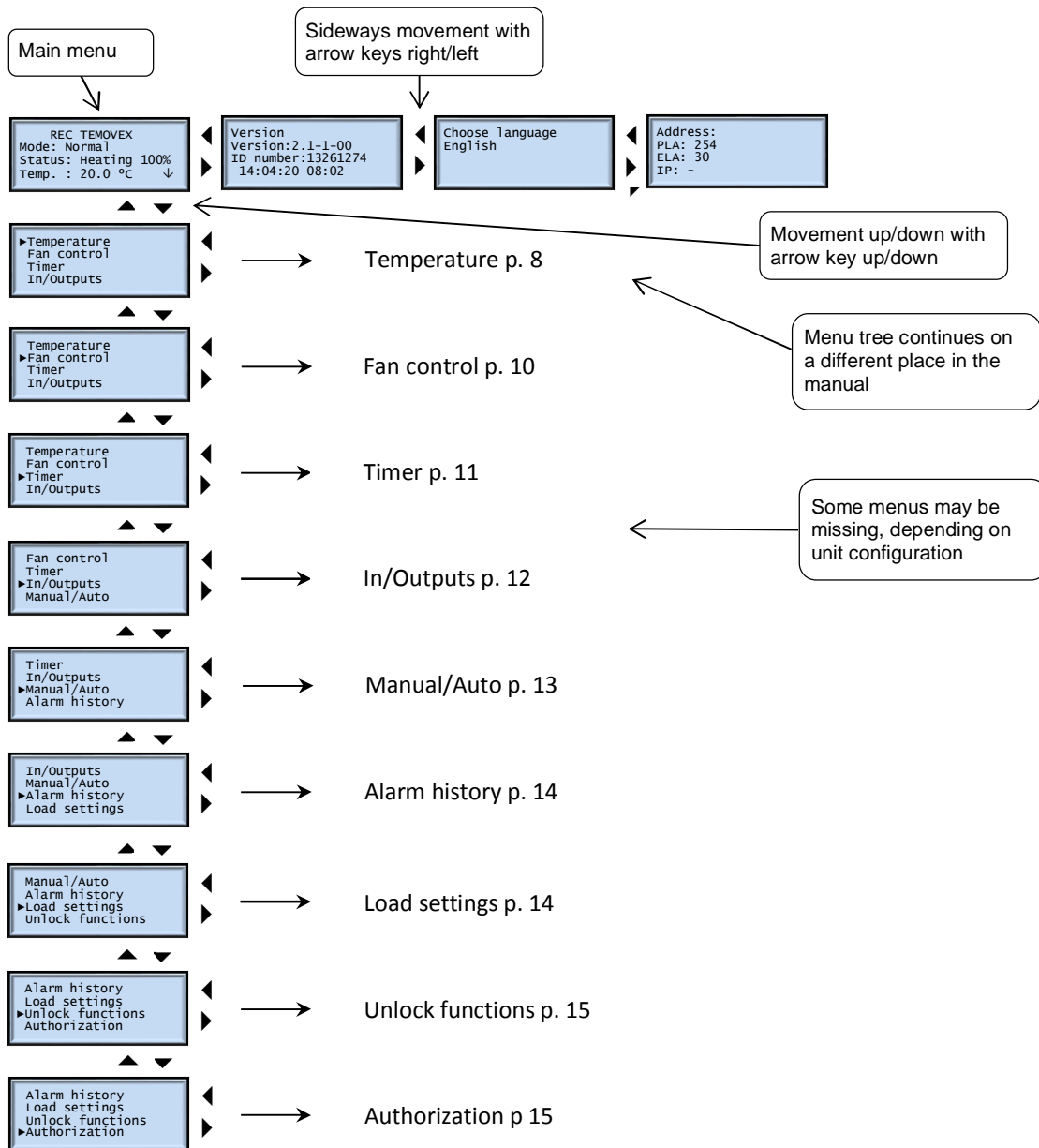

Main menu

Mode shows current fan mode. The unit can operate in several modes, depending on temperature and commands given to the unit etc. The options available are Stop, Low, Normal, Boost, Max, Kitchen mode, Stove mode, Night cooling, Defrost, ECO, Fire, ECO2 and Safe mode. For more info, please see the respective mode in the manual.

Status shows the current heating/cooling level and % output. Possible modes are Heating xx%, Bypass xx% and Cooling xx%. If all have 0% output, ----- 0 % is shown.

Temp shows current temperature set-point.

Version

Displays program version and control-electronics manufacturing number. Current date and time are also shown, which also can be changed here.

Language

Select Swedish, English or Polish.

Address

This shows the unit's address. Can be changed.

1. Temperature.

Temperatures

Outdoor temperature is measured on incoming air at the point where the sensor is located. The sensor is placed in the outdoor air duct as far from the unit as possible. The temperature may differ slightly from the actual outside temperature, which may depend on the length of the duct, insulation etc.

Supply air temperature is measured in the supply air duct normally about one meter away from the unit. Supply air is the fresh air that, after possible heating, is sent to the room.

Exhaust air temperature is measured in the exhaust air duct close to the unit. Exhaust air is the air that leaves the room and returns to the unit.

Extract air temperature is measured in the extract air duct close to the unit. Extract air is the air that, after the heat has been recovered, leaves the unit and is sent out of the house.

Room temperature is measured using an external sensor located in an appropriate place in the apartment/house.

Frost protection temperature is only used with water-based heating and shows the temperature of the return water from the heating coil. When the water temperature is too low the unit will stop, to prevent freezing of the water coil.

ECO adjust

ECO adjust is only used with exhaust air and room control and indicates a temperature range where heating and cooling is not active. E.g. with ECO adjust 2 degrees and a set-point of 20 degrees, heating and cooling will not be active between 18 and 22 degrees. ECO adjust is active when ECO is active.

Control mode

What is displayed under temperature depends on the type of control mode selected. There are five different control modes to choose from depending on the application: a) supply air control, b) cascaded exhaust air control, c) cascaded room control, d) outdoor compensated supply air control and e) zonal room control.

For the temperature setting and readout, select the column below corresponding to your configuration.

a) Supply air control

b) Exhaust air control

c) Room control

d) Outdoor compensated supply air control

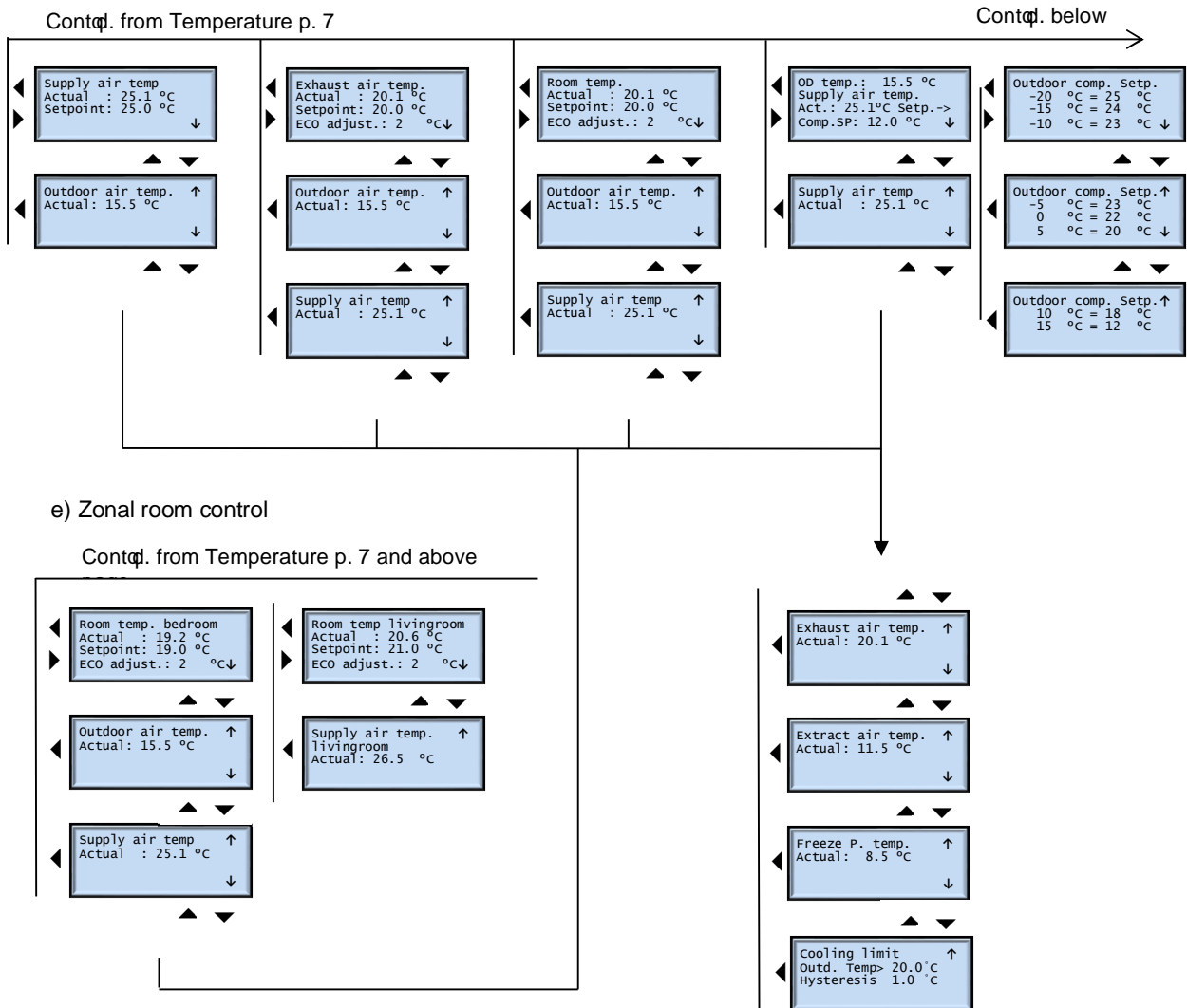

The menu frost protection temperature is only shown when water heating is configured.

Limit for cooling

The default setting is that cooling is not activated until the outside temperature is above +20 degrees. If you want to change this, set the outdoor temperature at which the cooling can start. There is also an adjustable hysteresis so that the cooling does not open and close all the time if the temperature is around the set value.

2. Fan control

In the operating menu you can set which mode the fans should run in. You can also see if the fans are running at fixed speed or variable. You can also see current values and setpoints. The set values are seen within parentheses.

Contol. from Fan control p. 7

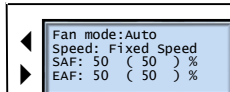

Fan control

In the fan control the following six modes are always available:

- **Auto:** The most optimal mode. This automatically controls the temperature acc. to the built-in and optimized algorithms of the system.
- **Min flow:** This forces the system to run with the set minimum flow.
- **Boost:** This forces the system to boost the flow. Useful if you, for example, quickly would like to air out.
- **Max flow:** When the fan runs with the set maximum flow.
- **Kitchen flow:** Used while the cooker fan is used. During kitchen flow the supply air fan normally has a higher flow than the exhaust air fan to compensate for the air that the cooker fan extracts.
- **Off:** In this mode all fans are off.

The following three modes are available if the feature is installed and configured. Even if the feature is not configured, it is visible and can be selected, but the system will after a few seconds revert to the previous selection.

- **Stove:** Used when a stove is being used. In the stove mode normally the supply air fan has a higher flow than the exhaust air fan to compensate for the air that the stove extracts.
- **ECO:** Only used with room control or exhaust air control when you are not home. The fans go down to minimum flow but are gradually increasing to normal flow based on heating or cooling needs. ECO adjust gives a temperature range around the setpoint where neither heating nor cooling is active.
- **Fire:** Not used on this unit!

3. Timer

In the timer setting menu, the clock can be set, and the timer configured.

Contd. from Timer p. 7

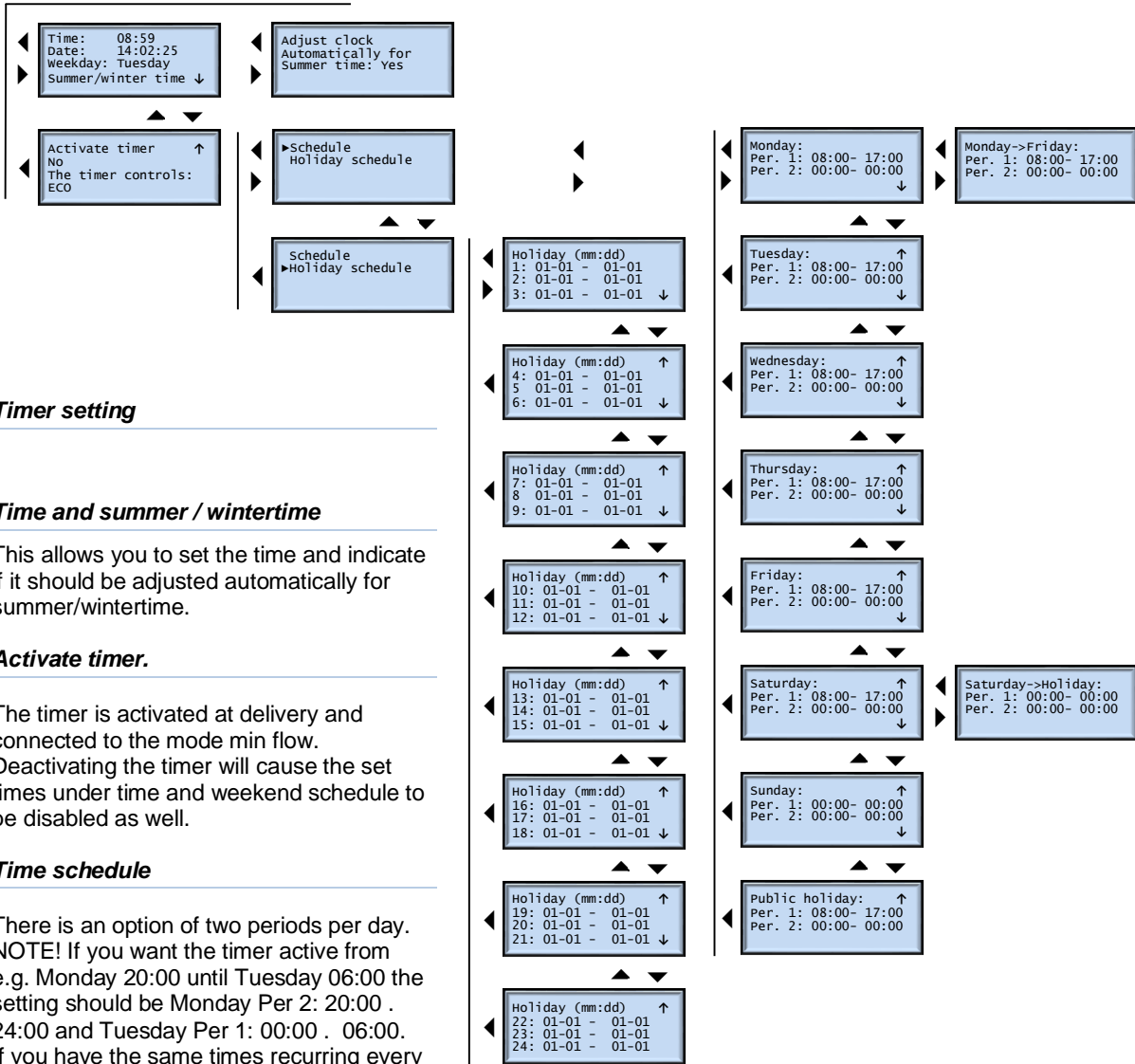

Timer setting

Time and summer / wintertime

This allows you to set the time and indicate if it should be adjusted automatically for summer/wintertime.

Activate timer.

The timer is activated at delivery and connected to the mode min flow. Deactivating the timer will cause the set times under time and weekend schedule to be disabled as well.

Time schedule

There is an option of two periods per day. NOTE! If you want the timer active from e.g. Monday 20:00 until Tuesday 06:00 the setting should be Monday Per 2: 20:00 . 24:00 and Tuesday Per 1: 00:00 . 06:00. If you have the same times recurring every day in the week you can use the function Monday → Friday.

If you want the same times on both Saturday, Sunday and all holidays (specified in the holiday settings), you can use the macro function Saturday → Holiday. Otherwise, there is a special menu for the holiday times.

Weekend schedule

Up to 24 separate holiday periods for a full year can be set. A holiday period can be any number of days, from 1 to 365, in sequence. The dates are in the format: MM:DD (Imagine that you are entering a time period from 00:00 one day until 00:00 the next day. For example, holiday June 6th is written 06:06 . 06:07.) When the current date falls within a holiday period the operating period for Holiday+ will be used.

4. Inputs/Outputs

In this menu the status of all inputs and outputs can be controlled. Sensors can also be calibrated.

Control from Inputs/Outputs p. 7

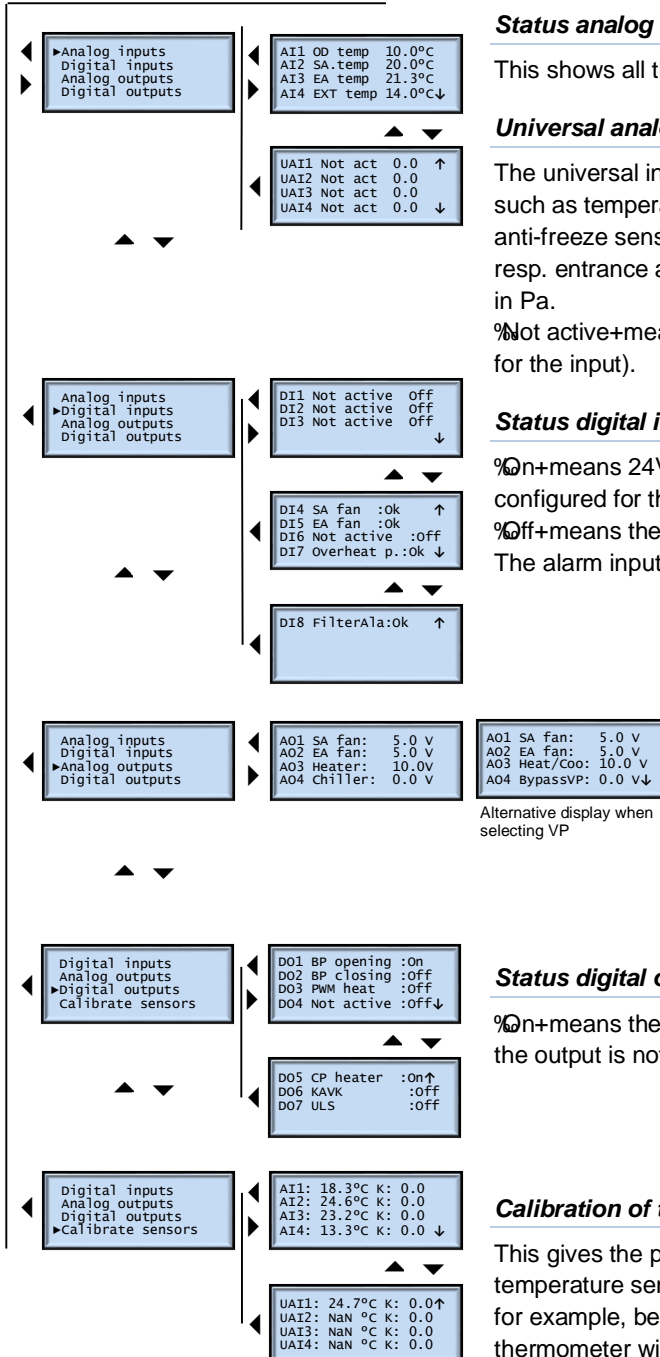

Status analog inputs.

This shows all the system's current temperatures.

Universal analog inputs.

The universal inputs can be configured for different purposes such as temperature or 0-10V input. Can be eg room sensors, anti-freeze sensors or pressure sensors, etc. Current values of resp. entrance are displayed. Temperature in °C and pressure in Pa.

%Not active+ means the input is not used (nothing is configured for the input).

Status digital inputs.

%On+ means 24V is applied on the input and the mode configured for the input is active.

%Off+ means the input is at 0V and the mode is not active.

The alarm inputs may have status ok or Alarm.

Status analog outputs.

This shows the current voltage on the output.

Status digital outputs.

%On+ means the output is active and %Off+ consequently means the output is not active.

Calibration of temperature sensors.

This gives the possibility to adjust the value for the temperature sensors up or down. (Set an offset value). May, for example, be used to synchronize the old normal thermometer with the system temperature. Input the difference here and they will display the same values.

5. Manual/Auto

Control from Manual/Auto p. 7

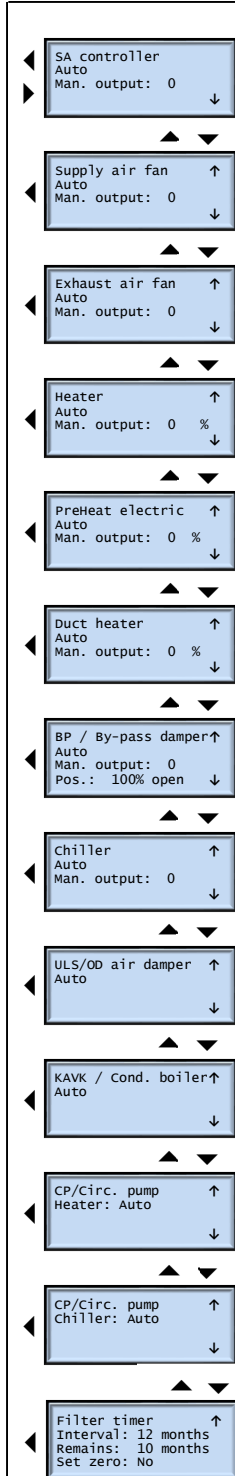

In Manual/Auto a great number of functions may be controlled manually, which is very useful for commissioning and troubleshooting.

All possible menus are shown on the side. In a real application all of these are never present simultaneously since there are not that many outputs, allowing for all to be configured at the same time, and also since perhaps certain functions are not needed in the application in question and thus are not configured.

If an output is manually controlled the normal control is rendered ineffective. Therefore, an alarm is generated as soon as any output is set to any other mode than Auto.

Supply air regulator

The supply air regulator signal may be manually varied between 0 and 100%. The output signal for the temperature control will follow if it is in the Auto mode.

Fans, bypass, heating and cooling

The operating mode of the fans can be controlled manually 0-100% as can heating, bypass and cooling. For the bypass damper the level of opening of the damper is also shown.

Digital outputs

All configured digital outputs such as ULS, KAVK, CP etc. can be set to Auto, On or Off, (or similar words indicating the two possible conditions of a digital signal).

Filter timer

The filter timer is also controlled here. You can set an interval between the filter changes of 6 - 18 months. In the menu the number of months remaining before the filters should be changed is shown. NOTE! This value is only updated once per day. I.e. if %Interval+is changed the %Time remaining+will not be changed before the next day.

When it is time to change filter, this is indicated on the display on the row %Mode+by having the existing text alternate with the text %Change filter+. After the filter change, you should reset the timer in this menu. NOTE! Even if you change filters prematurely (before the prompt appears on the display), you should reset the timer, to ensure the correct time interval for the next filter change.

6. Alarm

Current alarm

Current alarm and its status can be seen by pushing the red button. Here the alarms may also be acknowledged, blocked or unblocked (allow alarm). An alarm that was confirmed, but where the error was not fixed will show as a confirmed error in the menu. As soon as the error is fixed it will disappear from the menu (since it is already confirmed). You can also block an alarm in order to run the unit despite the alarm. **NOTE!** This you should not be done without proper knowledge, since it may cause danger and in worst case damage to property.

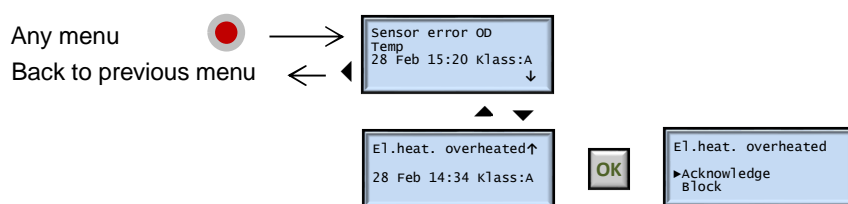

Alarm history

This shows the 21 latest alarm activities. E.g. when the alarm was triggered, when it was confirmed and/or reset etc. No alarms may be confirmed, blocked etc here.

Contøl. from Alarm history p.7

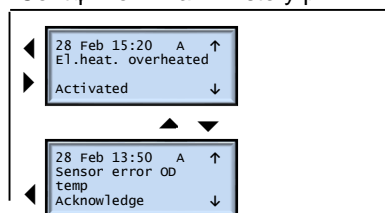

7. Load settings

Contøl from Load settings p. 7

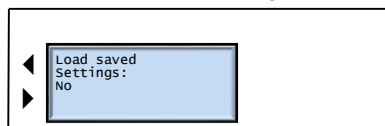

This reloads previously saved settings into the DUC, or if you have never saved anything the default settings. All settings are loaded except date and time.

8. Unlock functions

Contol from Unlock functions p. 7

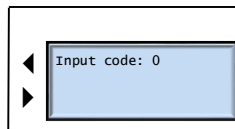

Used if you add functions afterwards. Please contact your supplier!

9. Authorization

Contol from Authorization p. 7



This is where a technician with proper access rights may log in to adjust the system and if necessary, change certain parameters.

Default user parameters setting.

Parameter	Default Setting	Parameter	Default Setting
Language	Swedish	Summertime	Yes
Address	254, 30	Activate timer	No
Setpoint supply air temp. control	19 _C	The timer controls	Min flow
Setpoint exhaust air control	21 _C	Schedule Monday-Friday	8-17, 0-0
Setpoint room control	21 _C	Holiday schedule	0-0
Outdoor compensated setpoint	25, 24, 23, 23, 22, 20, 18, 18	Holiday	01-01 . 01-01
Eco adjustment	2	Manual/Auto (all)	Auto
Cooling limit	Outd. Temp> 20.0_C Hysteresis: 1.0 _C	Filter timer	Interval 12 months
Fan Control	Auto		

Options

Remote panel Ę Simple (art.no. Q100446)



Remote panel - Simple

Remote panel - Simple (TG-R4) contains a temperature sensor and a set-point knob. The unit is used as a room thermostat, but also allows you to shift the set-point within a certain range.

The normal set-point is entered on the ventilation unit display and based on this value the set-point may be adjusted using the knob on the Remote Panel . Simple plus or minus a few degrees.

The adjusted set-point is shown on the main menu of the unit display. Remote panel . Simple uses analog transmission of values to the unit.

Remote panel Ę 3-way (art.no. Q100543)



Remote panel . 3-way

Simple remote panel for easy activation of normal mode, minimum mode (ECO) and forced mode.

Even potential alarms (red LED) are indicated on the panel.

Remote panel Ę with display (art.no. Q101299)



Away mode
Adjustment keys
Menu selection

Remote panel . with display is the most advanced remote panel. This also contains a temperature sensor and can be used as a room thermostat. It also has a display and some keys allowing you to see different temperatures and set them. You can also set the fan speed and see a lot of other information. In addition, it has an away key+built in.

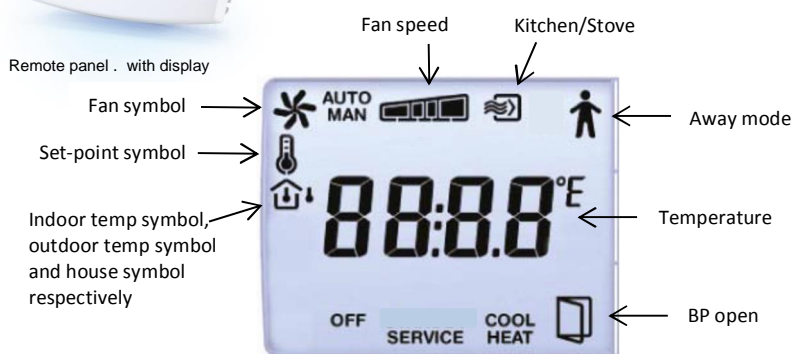

Temperature set-point display.

Normally (when you have not touched any key for the last 10 s) the set-point is shown on the display at the same time as the indoor temperature symbol and the house symbol are turned on.

Change of the temperature set-point.

Pushing once on the menu selection key will cause the set-point symbol to start flashing and the possibility is given to change the set-point using the adjustment keys. The value is saved when no keys have been touched for 10 s and the display reverts to showing the set-point.

Display of actual temperature.

Pushing once more (within 10 s) on the menu selection key will turn off the set-point symbol, the indoor temperature symbol will start flashing and the display will show the actual value. The adjustment keys have no function in this case. When the keys have not been touched for 10 s, the display will revert to showing the set-point.

Display of the outdoor temperature.

Pushing once more (within 10 s) on the menu selection key will turn off the indoor temperature symbol. At the same time the outdoor temperature symbol is turned on and the outdoor temperature is shown in the display. The adjustment keys have no function in this case. When the keys have not been touched for 10 s, the display will revert to show the set-point.

Fan speed:

Pushing once more (within 10 s) on the menu selection key will turn on the fan symbol and the fan speed as well as MAN or AUTO. The fan symbol will start flashing and the fan speed can be changed by stepping around to the desired mode (min, normal, forced or max) with the adjustment keys. The modes correspond to the setting in the menu selection Mode on the main display and a change on the remote panel will also be shown on the main panel.

The symbol MAN indicated that the unit is using a different mode than AUTO.

It may be that the unit is in a speed between min and max and normal and forced respectively due to forced or safe mode. The symbol fan speed will show the actual fan mode according to the following:

- | | |
|-------------------------------------|--|
| • At fan speed 0 | no box filled. |
| • < normal mode | leftmost box turned on |
| • = normal mode | the two leftmost boxes are turned on |
| • > normal mode but < = Forced mode | the three leftmost boxes are turned on |
| • = max mode | all boxes turned on |

If the unit on the main display is run manually using Hand/Auto the fan speed will not be changed when changed on the remote panel. What happens is that the changes are made on the symbols of the display and also on the main panel in the menu Mode but are not implemented on the fans until you exit the manual mode in Hand/Auto.

The new setting is saved when you continue with menu selections or after not having touched the keys for 10 s and the display reverting to showing the set-point.

Kitchen/Stove.

The symbol kitchen/stove is turned on when the unit is operated in the stove or kitchen mode.

Away mode/ECO mode.

Pressing the away key will turn off the away mode symbol and the unit changes to ECO mode.

An additional press will make the mode revert.

The mode assumes that ECO is activated on the unit under system.

Bypass.

The bypass symbol is turned on when the bypass is > 0 % open.

Cool.

COOL is turned on if cooling is selected under system and the cooling valve is open > 0 %.

Heat.

HEAT is turned on if the controller requests > 0 % heating.

Alarm.

SERVICE is turned on if there is an unconfirmed alarm on the unit.

Off.

OFF is turned on if the unit is in the off mode.

Stove mode



Extent.

The stove mode must be activated from the factory to make the stove mode work. In addition to the software configuration a momentary switch is included in the function (To connect and configure please see the Technician Manual). The stove mode means reduced exhaust air and increased supply air during the initial time after the stove has been lit. It means that the cooling is blocked so that you do not cool out the nice heating from the stove.

Start of stove timer.

Pushing once on the switch starts the stove mode and a timer starts counting down at the same time. If you regret the choice you can easily turn off the mode with a new push on the switch.

Stove indication.

That the stove mode is active is indicated on the indicator lamp in the switch.

For more extensive functional description see the Technician Manual under the section 7.15 I/O configuration.

Cleaning

Keep the unit clean for maximum performance and long service life. The filters should be changed at least once a year or more frequently if necessary. The fans and heat exchangers must be cleaned according to the instructions below.

Changing filters

The Temovex unit has two filters, exhaust air filter and outdoor air filter (fresh air). The filters should not be washed but replaced with new ones. New filters can be ordered from REC Indovent AB at www.rec-indovent.se or phone 031-675500.

 The unit must not be operated without the intended original filters. Operation without filters seriously affects the performance of the unit and can damage the unit's fans and heat exchangers.

- Switch of the power.
- Open the unit's door.
- Remove the long Cover plate.
- Take hold of the filter or of the clamp between the bags. Push the front part backwards, downwards.
- The supply air filter is behind the inner cover plate, behind the exhaust filter. Remove the filter.
- Clean accessible surfaces if necessary.
- Fit the new filters in reverse order (the blue, exhaust air filter, is fitted in the front).
- Refit the cover plate.
- Close the door.
- Turn on the power.



The unit operates even if the filters are dirty, but the performance would be less good, energy consumption increases and heat recovery decreases.

Reset filter alarm: See Chapter 5.

Cleaning the fans

- Switch of the power.
- Open the unit's door.
- Remove both covers.
- Disconnect the fan's electric plug and pull out the fan. (Clean one fan at a time).
- Clean the impeller using a brush or compressed air.
- Refit the fans in reverse order.
- Refit the covers.
- Close the door.
- Turn on the power.



NOTE! The fans must under no circumstances be cleaned under running water!



Cleaning the heat exchanger

- Switch of the power.
- Open the unit's door.
- Remove both fans (see above).
- Open the inspection door by the bottom of the unit.
- Remove the red plug at the bottom of the unit, the condensate drain.
- Flush the heat exchanger with hot water.



NOTE! If the unit is fitted with a condensate evaporator unit (KAVK), a wet vac should be used to deal with the rinse water.

A degreasing agent may be required if the heat exchanger is very dirty.



NOTE! The agent must be of a type which is not aggressive to aluminium. Alkaline detergents with caustic ammonia and alike must never be used, since they have a corrosive action on aluminium, i.e. ruin the heat exchanger.

- Refit the red plug (On the same side of the unit as the filters).
- Refit the inspection door.
- Refit the fans in reverse order.



NOTE! Make sure the fan motors are not/do not get wet when restarting the unit. If wet, this could be fatal!

- Refit the covers.
- Close the unit door.
- Turn on the power using the main switch.

Checking the condensate drain

- Open the unit's door.
- Open the access door at the bottom of the cabinet.
- Make sure the drain is not blocked. This can be done by pouring some water into the bottom of the unit.

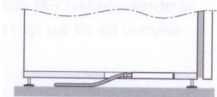

NOTE! On the side which does not have a red plug.

- If the drain is jammed, try to remove the obstruction. If need be, call a plumber.
- Refit the access door.
- Close the unit door.

Cleaning the air diffusers

The building's air diffusers must be cleaned regularly in order to maintain correct ventilation. Use a dry cloth and/or a small brush to reach inside the opening of the diffuser. It can also be taken down if that makes cleaning easier. Use a duster or a dry cloth to remove possible dirt marks in the ceiling around the device.



NOTE! The air diffuser's setting must not be changed. If taken down, each diffuser must be returned to its original place.

Cleaning the duct system

The exhaust air ducts - and sometimes the supply air ducts as well - may need cleaning at long intervals. Dust and dirt will deteriorate the capacity of the AHU if not removed.

Authorized ventilation cleaners should carry out the cleaning.

However, you yourself can easily clean the part of the duct which is close to the air diffusers.

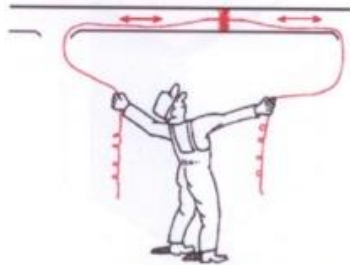

Take down the diffuser. Use a vacuum cleaner or duster to clean the inner part of the duct as far as you can reach. Refit the diffuser, making sure the setting is not changed.

Checking the outdoor air intake

Once a year the outdoor air intake should be checked. Make sure it is not clogged by for example leaves, snow or ice.

Service

Service and repairs, beyond normal maintenance, should be carried out by professionals in the ventilation field, or - if electricity is involved - by an authorized electrician.



The electric panel must not be opened by other than authorized specialist.



The plates covering the fans must not be removed when the AHU is running, as there is a risk of contact with moving parts. Make sure the electricity has been cut off (unplugged or fuse removed).



Interference with the AHU system may affect the warranty terms.



Use original spare parts only.

Disposal and recycling

The unit has a long service life if it is properly maintained and can be renovated to advantage.

Spare parts - see www.shop-recvent.se

When the unit is to be disposed of: see information on waste management and recycling on our website.

Prevent accidents when the AHU is disposed of. Remove the cable from the wall socket and cut it as close to the unit as possible. Store and transport the waste unit lying down.

Please leave the unit to be recycled where such facilities exist. Check with your local authority for recycling advice.

List of abbreviations

AHU	air handling unit
BP	by-pass damper
Comp.	compensate(d)
CP	circulation pump
DUC	controller
EA	exhaust air
El.heat.	electric heating
EXT	extract air
FRP	freeze protection
h	hour
Int.	Internal
KAVK	condensation boiler
mm:dd	month:day

OD	outdoor
P	protection
per	period
pos.	position
RM	room
s	second
Setp.	setpoint
SA	supply air
Temp.	temperature
ULS	outdoor air damper

DATE is shown in the format YY-MM-DD.

TIME is shown in 24-hour format.

Notes:

Notes:

Notes:



REC Indovent AB reserves the right to make alterations to specification and construction without prior notification.



REC Indovent AB

Box 37, SE-431 21 Mölndal, Sweden
Visiting address: Kärragatan 2

Tel: +46 31 67 55 00

Fax: +46 31 87 58 45

www.rec-indovent.se

Certified according to ISO 9001/14001